



The Chef Food Slicer & Grater is perfect for moderate to high-volume use in larger restaurants, supermarkets and delicatessens.



Model  
**CHEF300**  
Food Slicer & Grater



Medium Duty; Manual Operation; CE Approved

# Model CHEF300

## Food Slicer & Grater

CE Approved

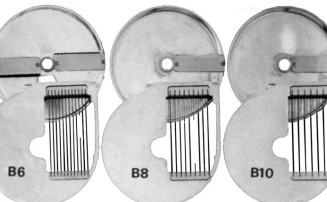
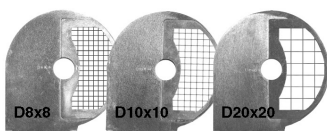
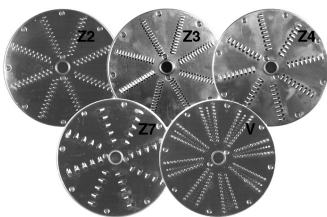
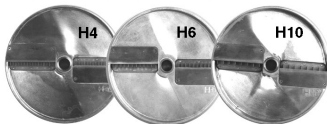
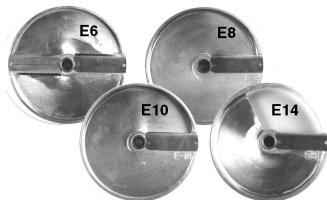
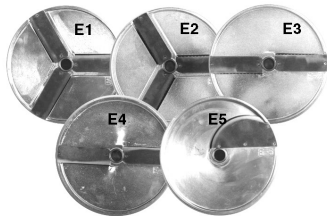

The Chef Food Slicer & Grater has been designed for moderate to high-volume use in larger restaurants, supermarkets and delicatessens.

Convenience features include, fast blade change and dual inlet chutes, which make for fast and efficient slicing of any kind of fruit or vegetable in the busiest environment.

- Manufactured in anodised aluminium and stainless steel to resist the corrosive effects of salts and acids;
- Constructed for easy cleaning;
- Up to 60 different slicing and grating combinations;
- Safety interlock switches prevent operation if the machine is opened or the feeder handle is not closed;
- Forced ventilation to motor.

### SLICING DISCS

**E1, E2, E3, E4, E6, E8, E10 & E14:** For slices from 1 to 14 mm. Potato chips, potato, turnip, cabbage, cucumber, carrot, mushroom, onion, marrow, aubergine, fennel, artichoke.

**E5, E15 & E25:** For slices from 1 to 5 mm. Hard salami, mushroom, tomato, lemon, orange, apple, banana, pineapple, grapefruit, etc.

**E30, E40, E60, E80, E100, & E140:** For fruit and vegetable waved slices from 1 to 14 mm.

**VE3, VE4, VE, 6 & VE 8:** Use to slice complete vegetables. White cabbage, red cabbage, etc.

## SPECIFICATIONS

Model	300
Blade (mm)	205
Motor	240V, 50Hz, 380W,
Net weight (kg)	18.5
<b>Dimensions (mm)</b>	
Width (B)	240
Depth (C)	570
Height (A)	470

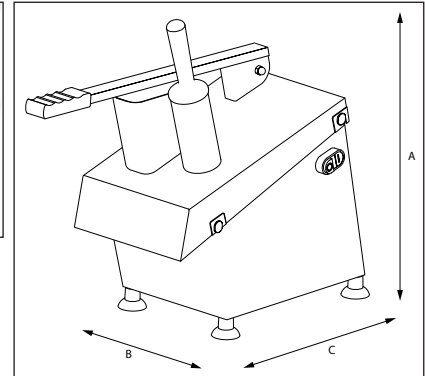

### MATCH-LIKE CUTTING DISCS

**H2.5, H4, H6, H8 & H10:** Celery, marrow, beetroot, carrot, potato, cabbage, etc.

### SHREDDING OR GRATING DISCS

**Z2, Z3, Z4 & Z7:** Carrot, celery, potato, apple, turnip, beetroot, red cabbage, cheese, chocolate, etc.

**V:** Cheese, dry bread, nuts, chocolate, etc.

### CUBIC CUTTING DISCS

**D8x8, D10x10, D12x12, D16x16 & D20x20:** Used in combination with any of the E series discs produces three different sizes of cubes or strips for use in soups, fruit salads, etc.

### CHIPPING GRID DISCS

**B6, B8 & B10:** Use in combination with E series discs to obtain matchlike chips. Use with the Eo series discs to produce chips with waved sides.



Brice Australia Pty. Ltd. ABN 71 413 589 669  
100% Australian owned and operated  
Copyright ©2017 Brice Australia Pty. Ltd.

**BRICE HEAD OFFICE:**  
11 Holloway Drive,  
Bayswater, Victoria 3153 Australia

**Ph: 1300 664 880**  
[www.briceaust.com.au](http://www.briceaust.com.au)  
email: [info@briceaust.com.au](mailto:info@briceaust.com.au)